

# Wifi 2.4GHz Antenna Specification

MODEL NO.:RY-2.4G-02



## ( I ) Product Overview

Frequency (MHz): 2400-2500

VSWR  $\leq$  1.5

Gain (dBi): 2.15

Max Input power (W): 50

Input Impedance ( $\Omega$ ): 50

Polarization: Vertical

Antenna Length (mm): 110(overall length)/90(swiveled)

Antenna colour: black

Connector: SMA rp male

Storage Temperature: -30 °C to+75°C

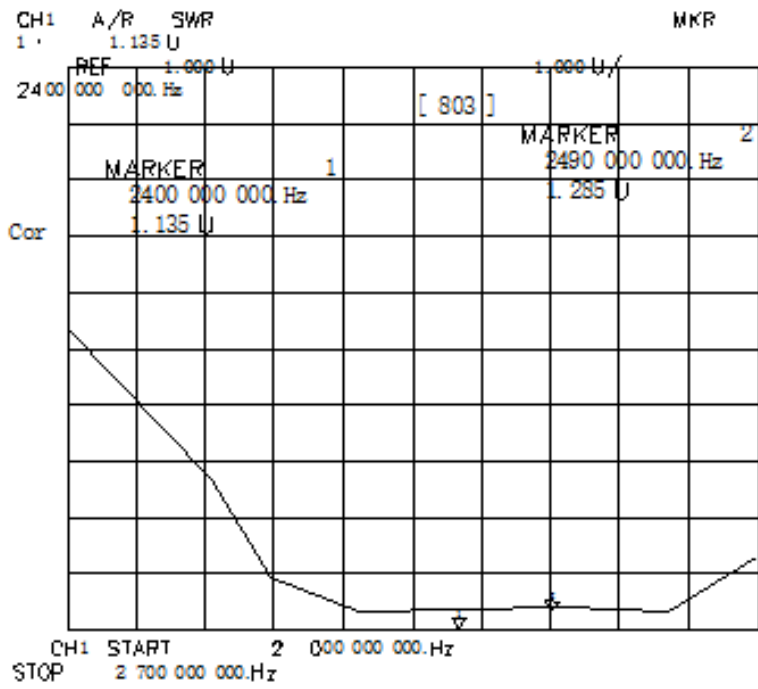
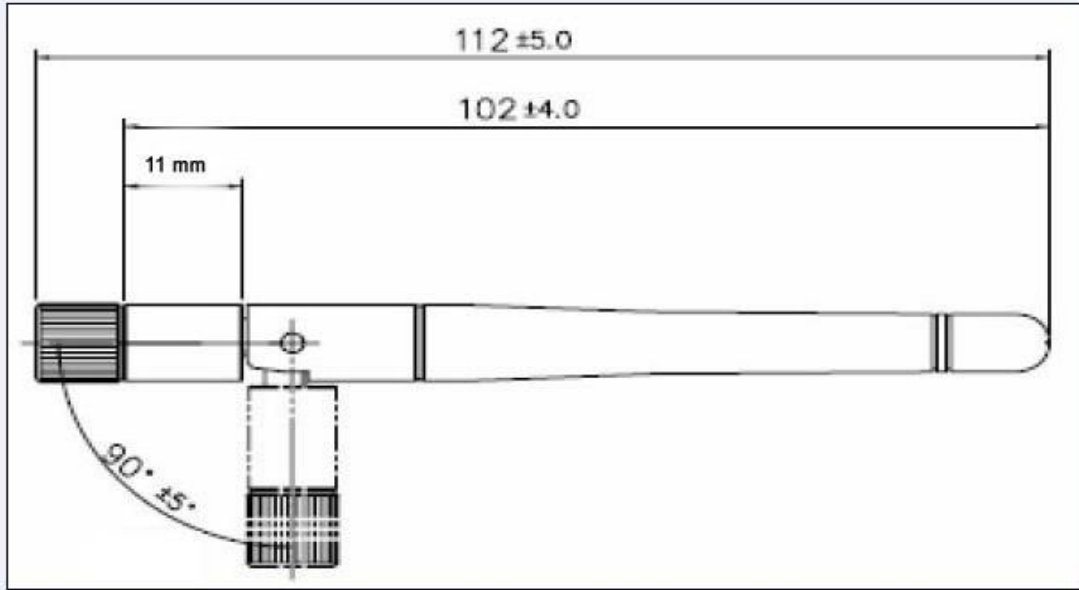

Operating Temperature: -30°C to+75°C

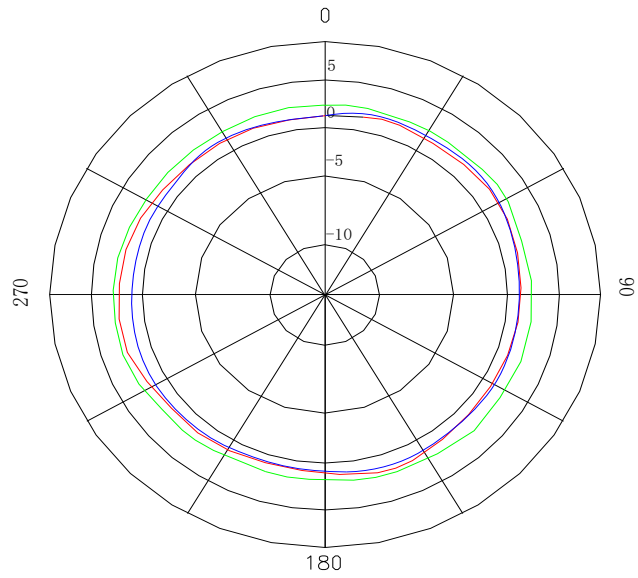

## 2. 4G天线极化图



水平面方向图(2.4G天线)  
Horizontal Pattern

	FRE (MHz)	Max dBi	Min dBi
	2400	2.75	2.11
	2450	3.03	2.68
	2500	2.56	1.67

2400MHz

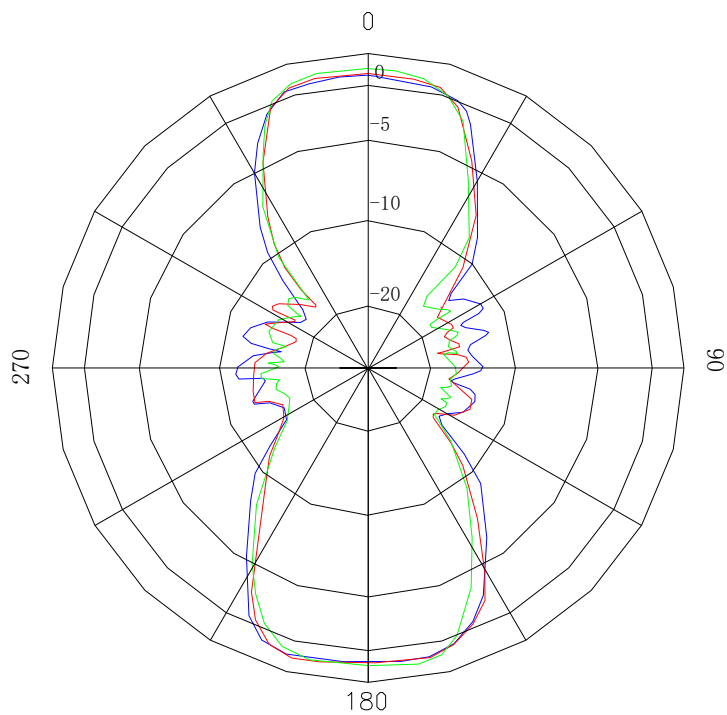

垂直面方向图  
Vertical Pattern

- 2400MHz
- 2450MHz
- 2500MHz